

目 录

一、运输作业组织与管理模块..... 2

二、仓储与配送作业组织与管理模块..... 34

三、国际物流作业组织与管理模块..... 150

四、 快递物流作业组织与管理模块.....	213
-----------------------	-----

湖南商务职业技术学院物流管理专业学生技能考核题库



--	--	--

○

○

--	--	--	--	--

() 任务描述

- :
-
-



<input type="checkbox"/> <input type="checkbox"/>				<input type="checkbox"/> <input type="checkbox"/>				
<input type="checkbox"/> <input type="checkbox"/>								
						<input type="checkbox"/> <input type="checkbox"/> <input type="checkbox"/> <input type="checkbox"/>		



() 任务描述:

-
-
-



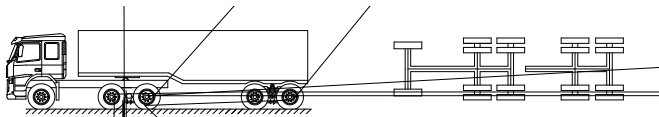
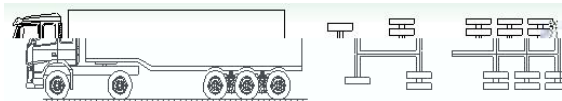

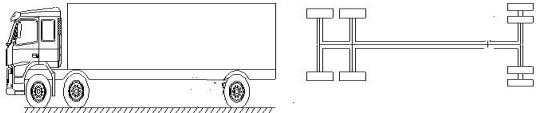
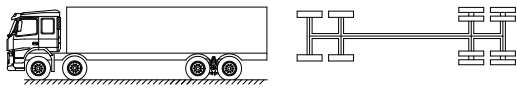
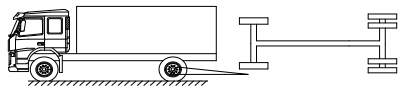
--	--	--	--	--

() 任务描述:



○

○

○

○

○

() 任务描述



D

<input type="checkbox"/> <input type="checkbox"/>			<input type="checkbox"/> <input type="checkbox"/>						
<input type="checkbox"/> <input type="checkbox"/>									
						<input type="checkbox"/> <input type="checkbox"/> <input type="checkbox"/> <input type="checkbox"/>			





2

3

4

() 任务描述

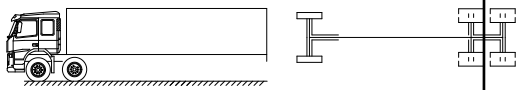
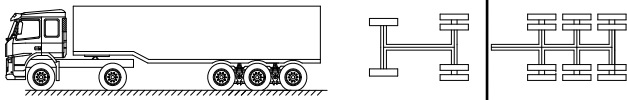
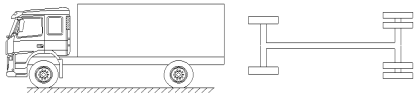



() 任务描述

-
-
-
-
-

() 任务描述

()

()

)	()		

()

()

()

()

()

○

()			

Sailing Schedule from : Shenzhen,Shenzhen,Guangdong,China	
To : Los Angeles,Los Angeles,CA,United States	
Origin City : Shenzhen,Shenzhen,Guangdong,China	CY/DOOR
Destination City : Los Angeles,Los Angeles,CA,United States	CY/DOOR

序列号	航线	船名	航次	截关时间	装货港	预计离港时间	实际离港时间	卸货港
1	YPSW	YM UNISON	59E	2016-04-22 17:00	Yantian	2016-04-25		Los Angeles
2	SEA	NORTHERN JAVELIN	002E	2016-04-23 12:00	Yantian	2016-04-27		Long Beach
3	AAS2	CMA CGM LIBRA	095TXE	2016-04-25 16:00	Yantian	2016-04-28		Long Beach
4	YPSW	YM UBIQUITY	22E	2016-04-29 17:00	Yantian	2016-05-02		Los Angeles
5	SEA	C/SCL PUSAN	117E	2016-04-30 12:00	Yantian	2016-05-04		Long Beach
6	AAS2	CMA CGM COLUMBA	097TXE	2016-05-02 16:00	Yantian	2016-05-05		Long Beach
7	SEA	COSCO NINGBO	069W	2016-05-06 11:00	Yantian	2016-05-09		Long Beach
8	SEA	COSCO (COSCO LINGBO)	070W	2016-05-06 11:00	Yantian	2016-05-09		Long Beach
9	AAS2	CMA CGM (CMA CGM LIBRA)	096TXE	2016-05-08 16:00	Yantian	2016-05-11		Long Beach
10	YPSW	YM (YM UBIQUITY)	23E	2016-05-11 17:00	Yantian	2016-05-14		Los Angeles
11	SEA	C/SCL (C/SCL PUSAN)	118E	2016-05-11 12:00	Yantian	2016-05-14		Long Beach
12	AAS2	CMA CGM (CMA CGM COLUMBA)	098TXE	2016-05-13 16:00	Yantian	2016-05-16		Long Beach



干货箱



	箱体内部尺寸			箱体内容积及载重量		箱门开度尺寸	
	L	W	H	Cu	P	W	H
20'	5898	2352	2393	33.2	21740/28230#	2340	2280
40'	12032	2352	2393	67.7	26630	2340	2280
HC	12032	2352	2698	76.3	26520	2340	2585

冷藏箱



	箱体内部尺寸			箱体内容积及载重量	
	L	W	H	Cu	P
20'	5444	2284	2267	28.5	21135/27160#
40'	11583	2284	2250	58.7	26580
HC	11583	2284	2659	67.9	26380

开顶箱



	箱体内部尺寸			箱体内容积及载重量	
	L	W	H	Cu	P
20'	5900	2330	2337	32.6	21740
40'	12025	2330	2337	65.8	26410

○

○

() 实施条件

() 考核时量

() 评分细则

1

() 任务描述



		<input type="checkbox"/>	<input type="checkbox"/>	<input type="checkbox"/>	<input type="checkbox"/>

□		□			
□		□			



() 实施条件

() 考核时量

() 评分细则

1

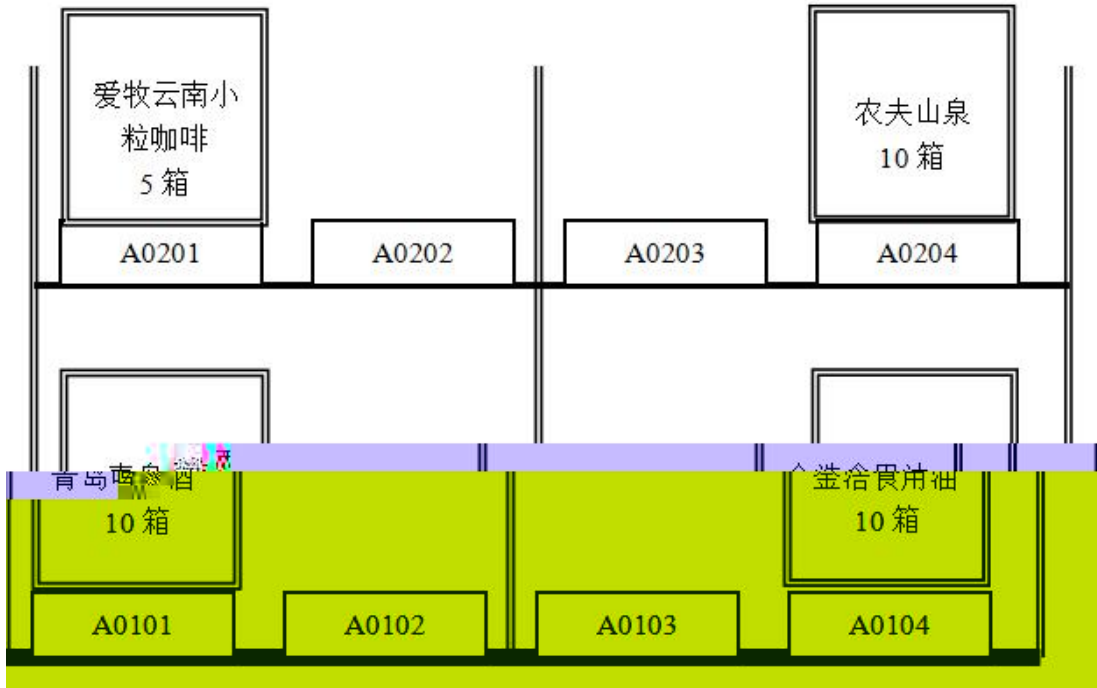

产品运输单

-
-
-
-
-
-
-
-

80				

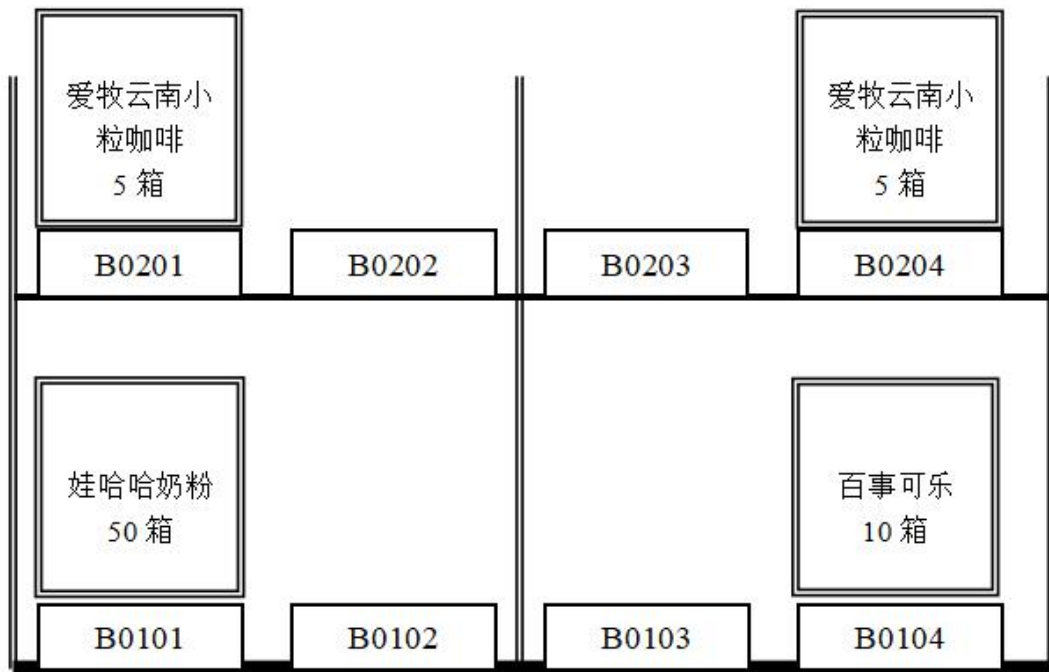
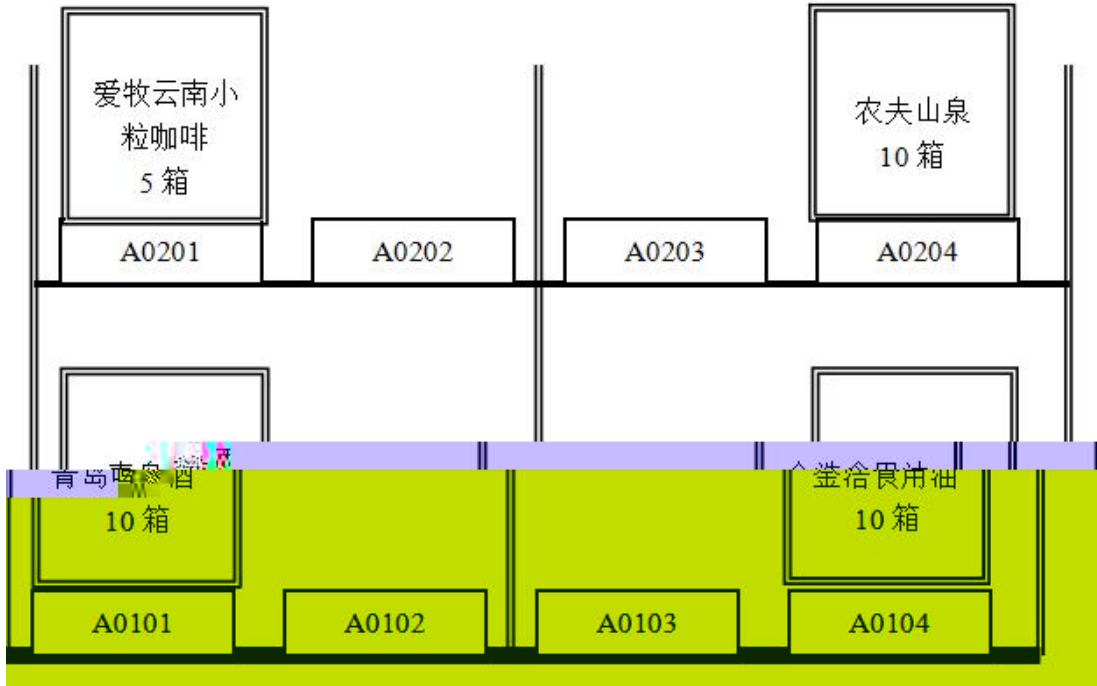

产品运输单

-
-
-
-
-
-
-
-

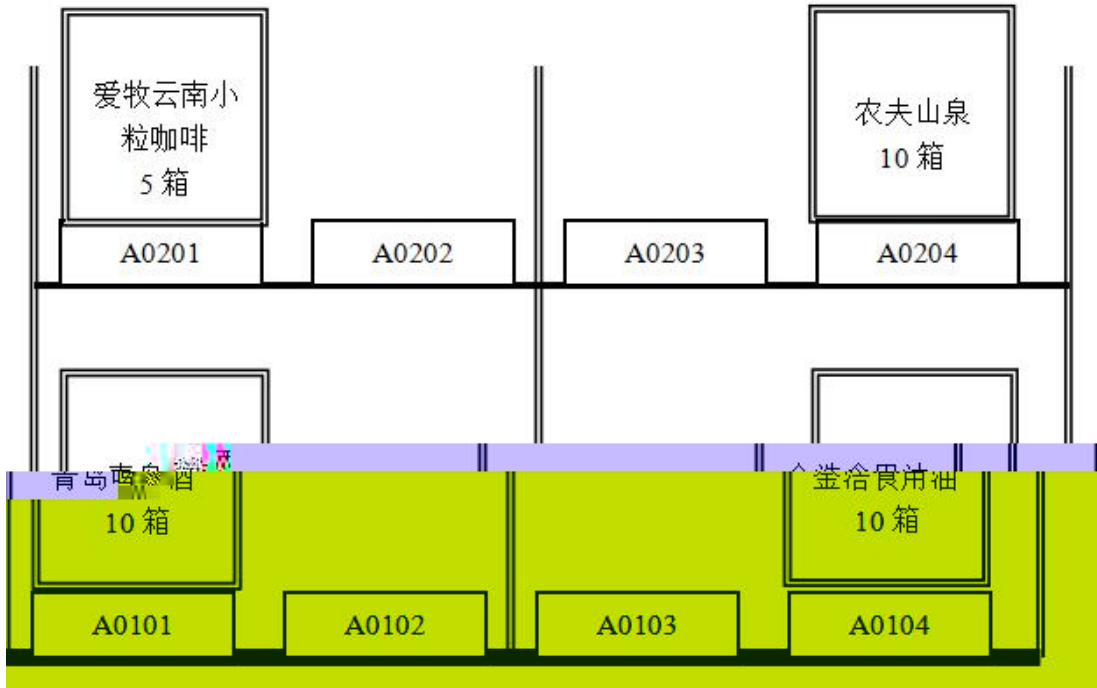

物品运输单



-
-
-
-
-
-
-
-

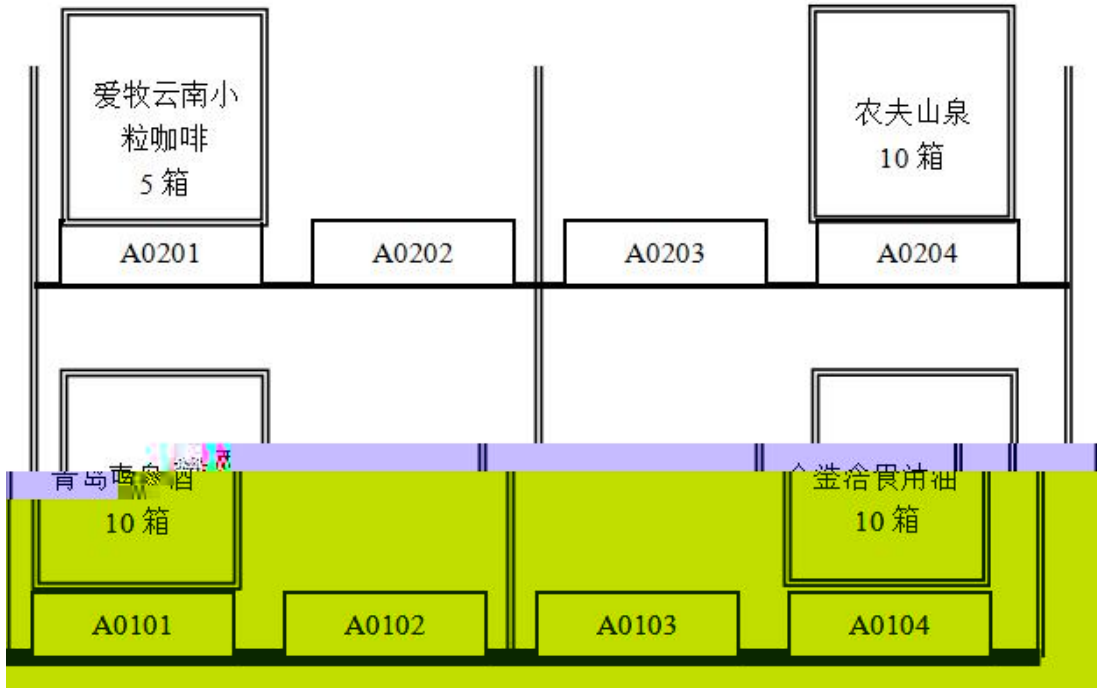

产品运输单

-
-
-
-
-
-
-
-

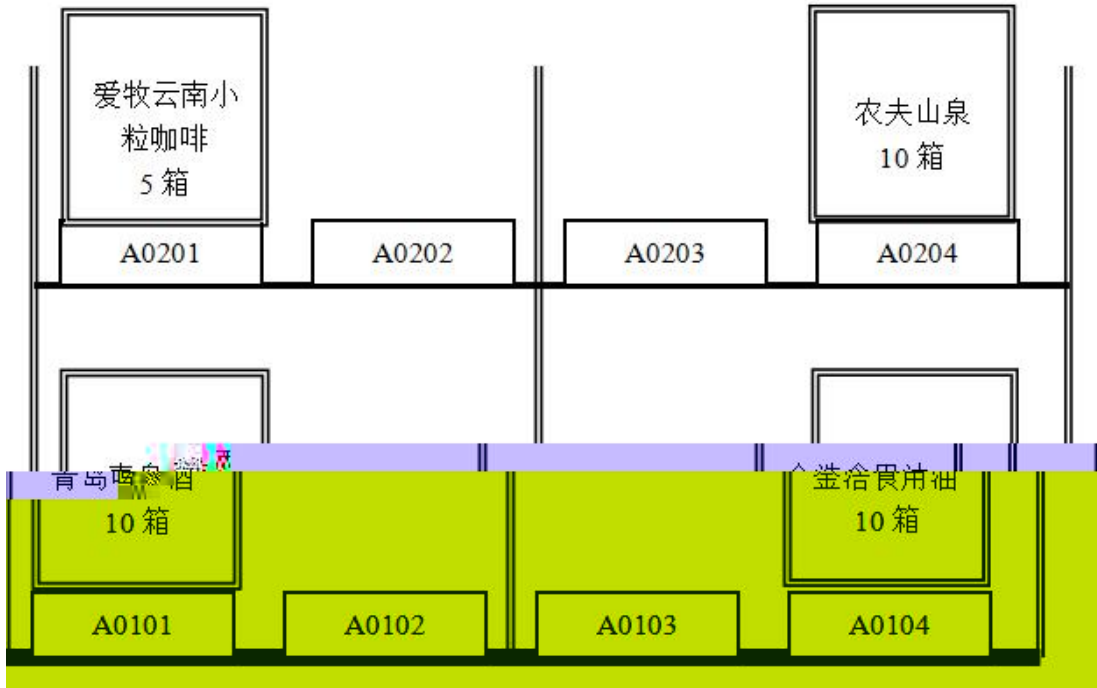

产品运输单

○

○

○

○

○

5 ÑL0

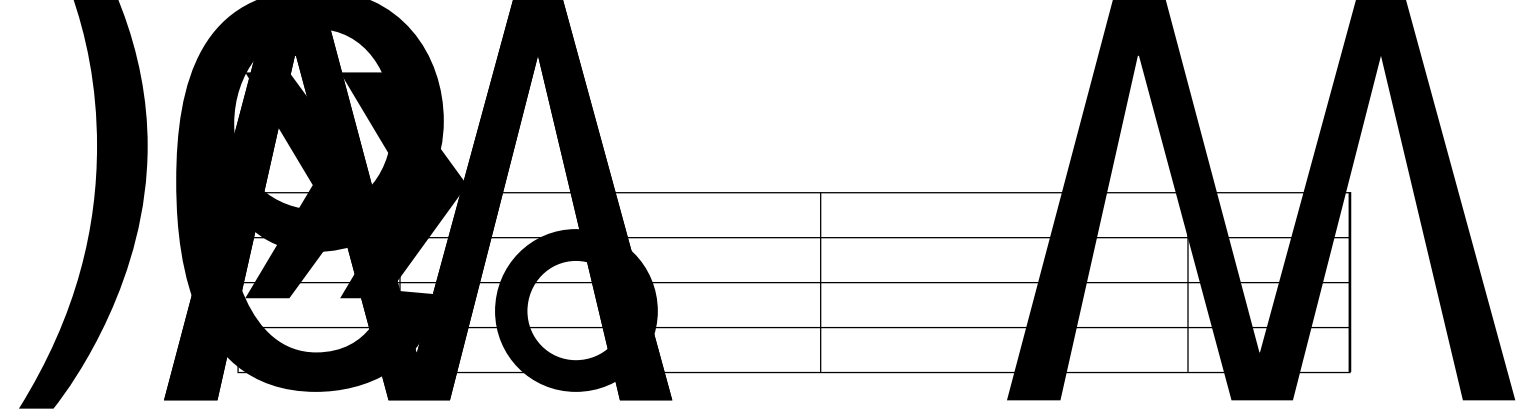

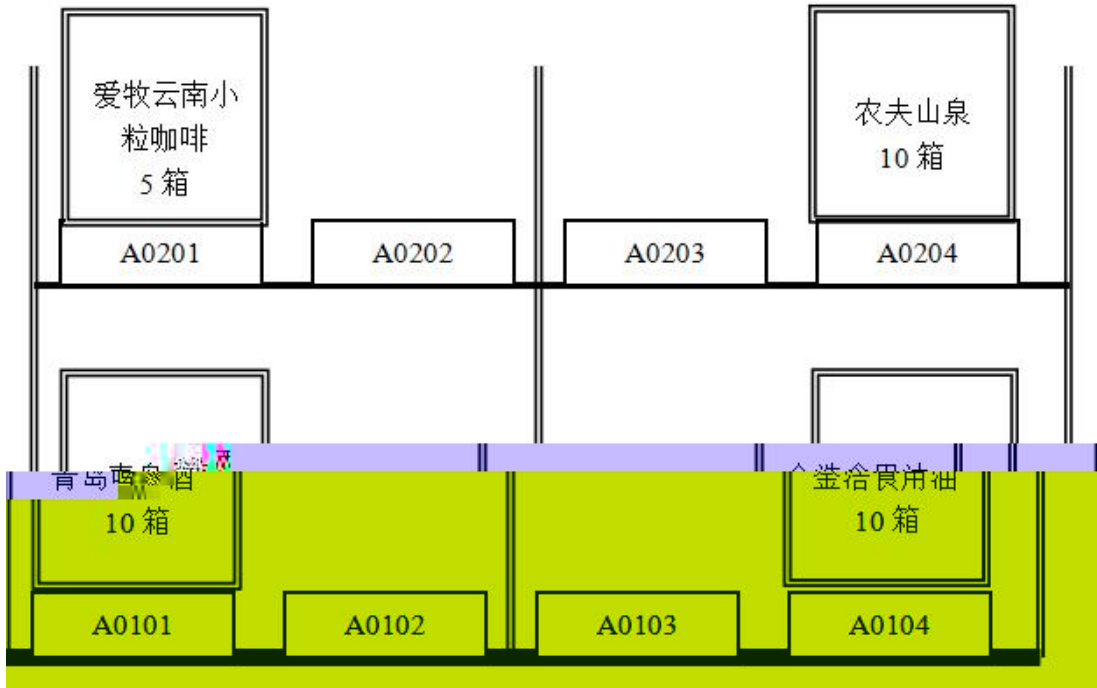

产品运输单

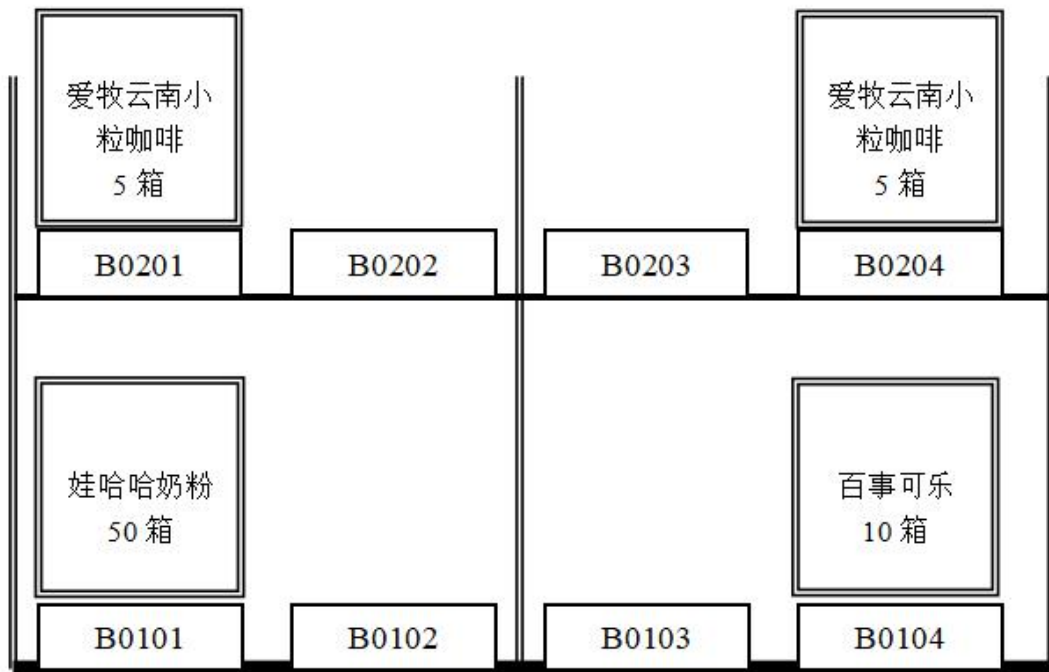
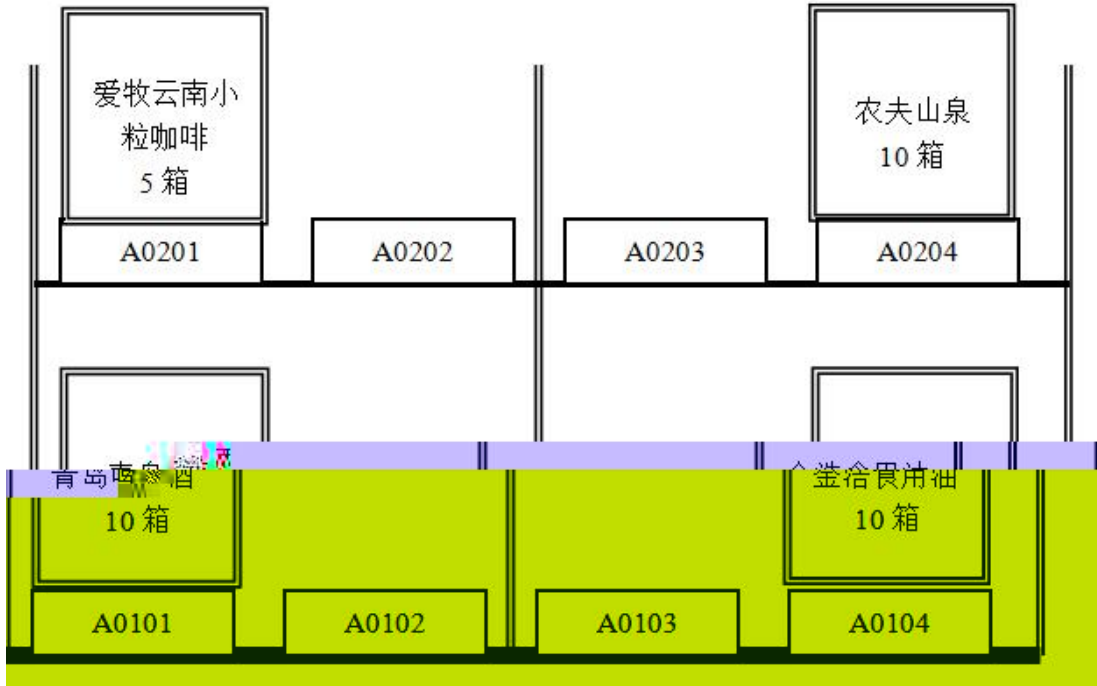

产品运输单

-
-
-
-
-
-
-
-
-

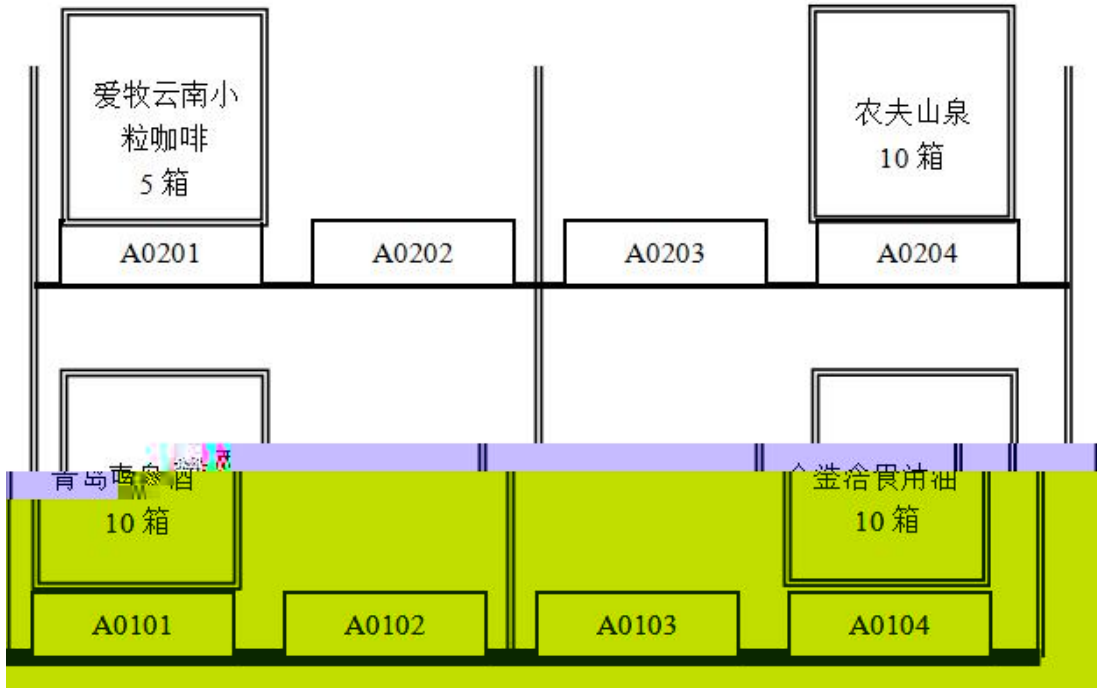

产品运输单

-
-
-
-
-
-
-
-
-

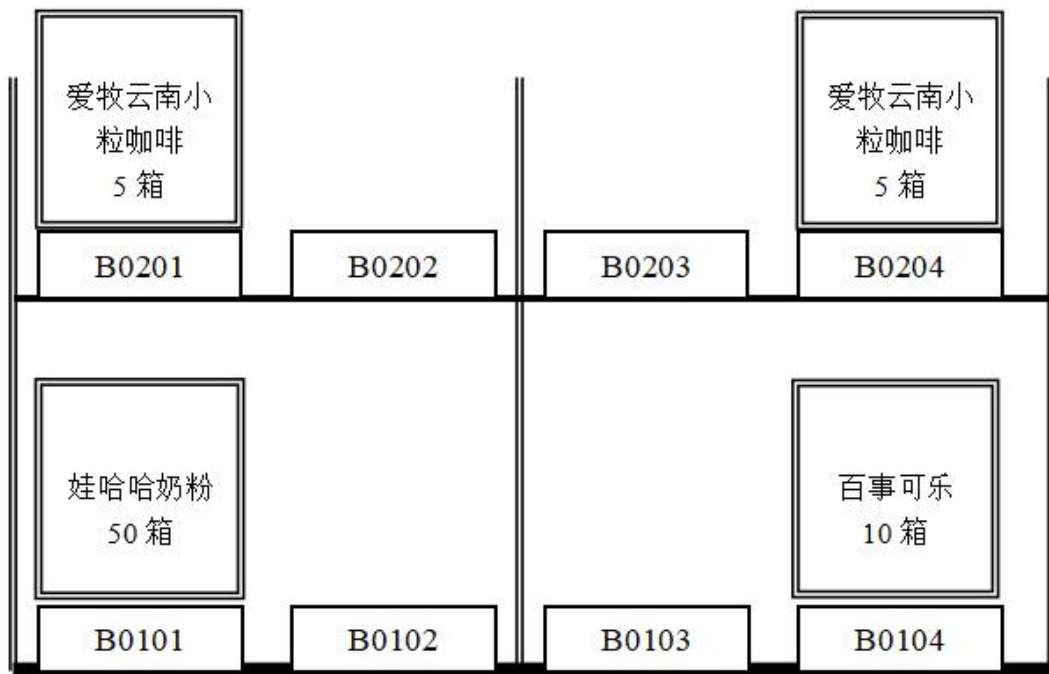
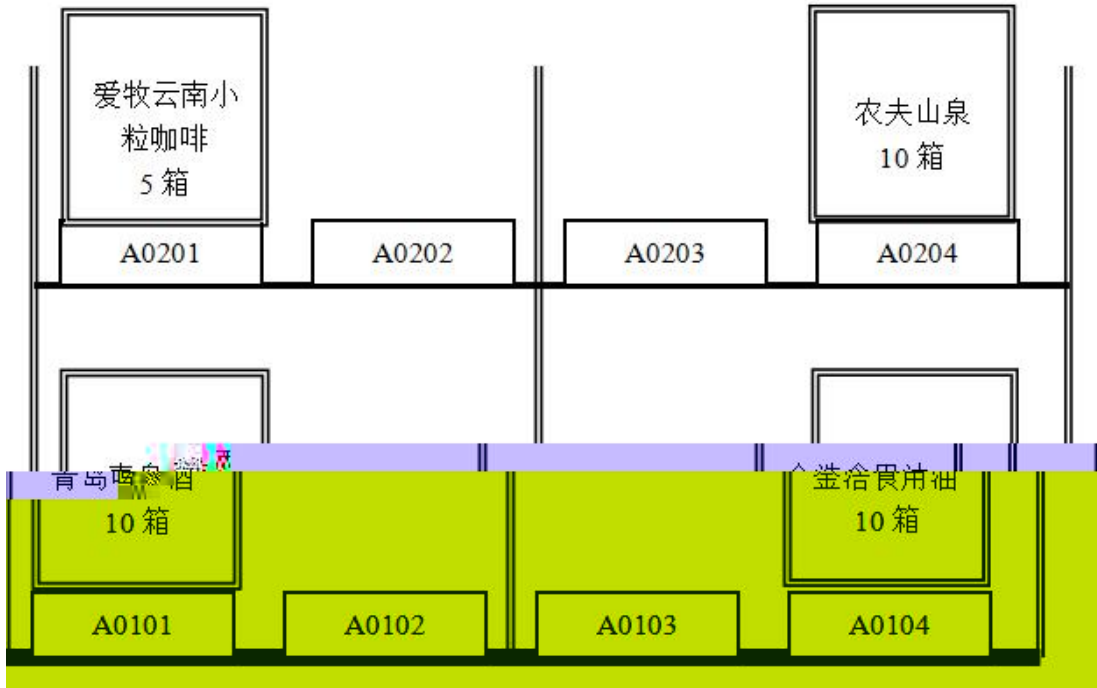

产品运输单

-
-
-
-
-
-
-
-
-

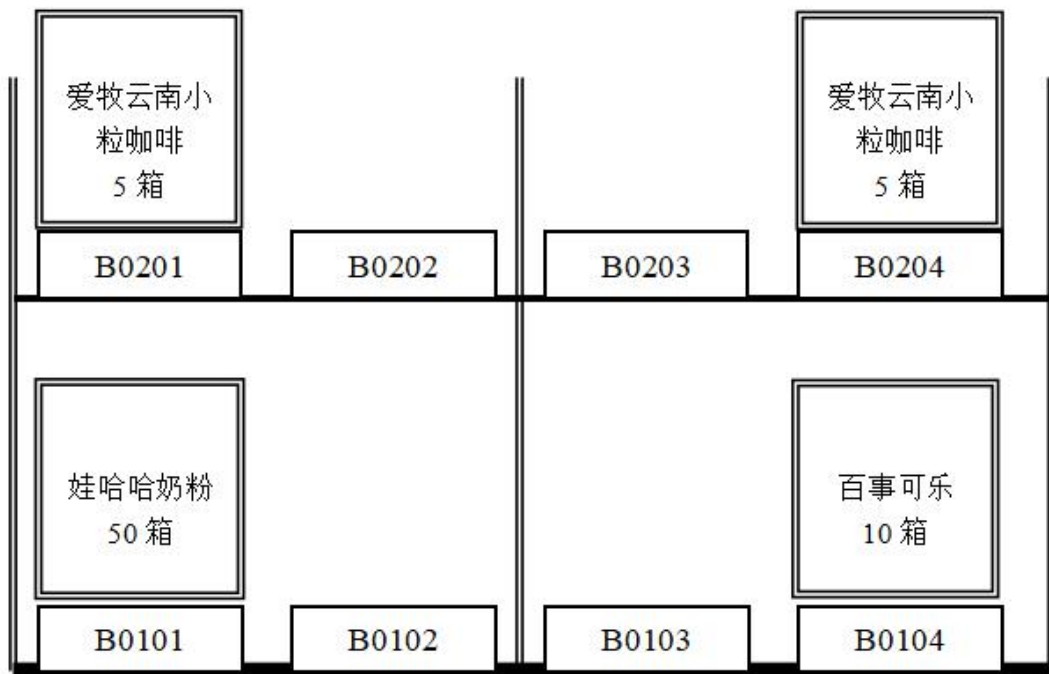
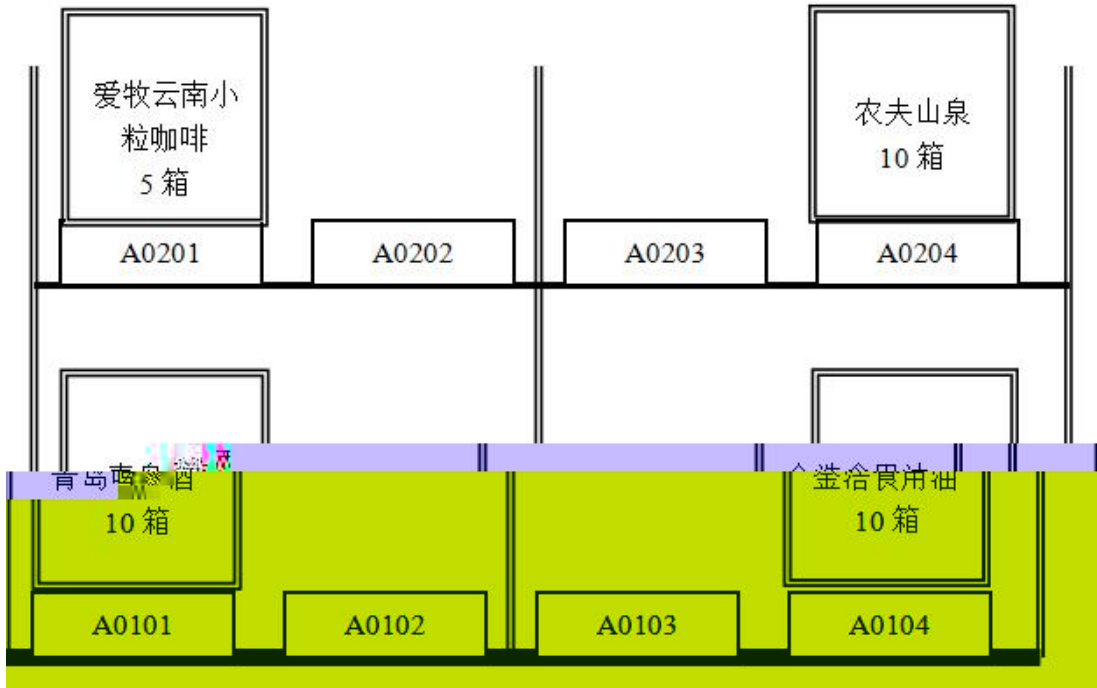

产品运输单

-
-
-
-
-
-
-
-

○

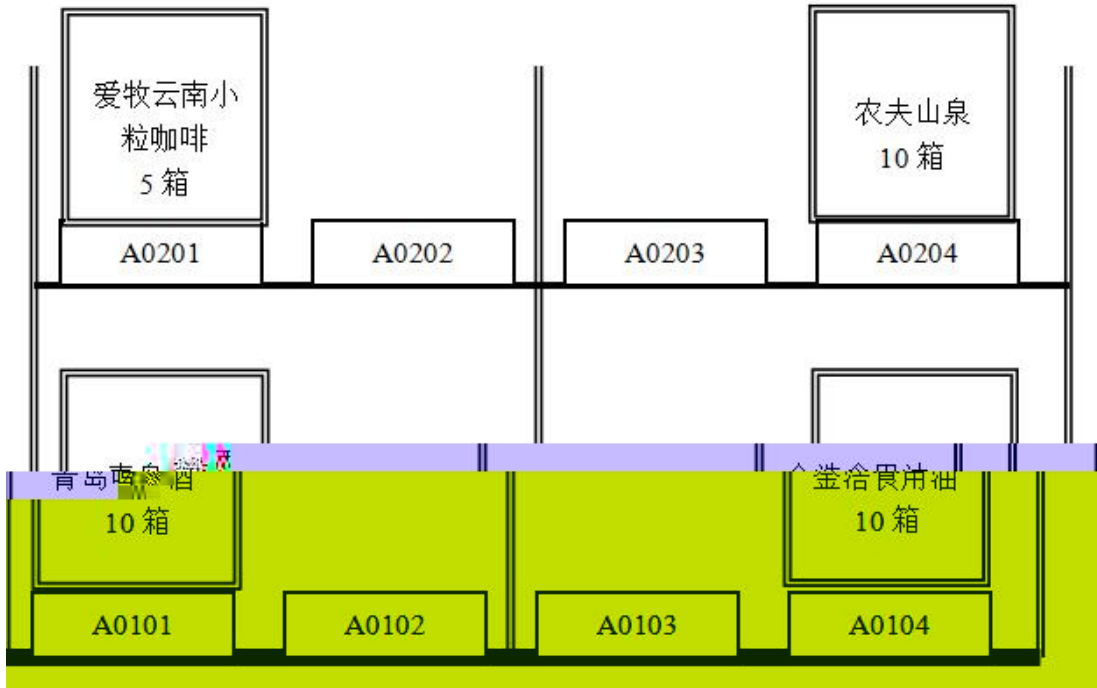



--	--	--	--	--	--

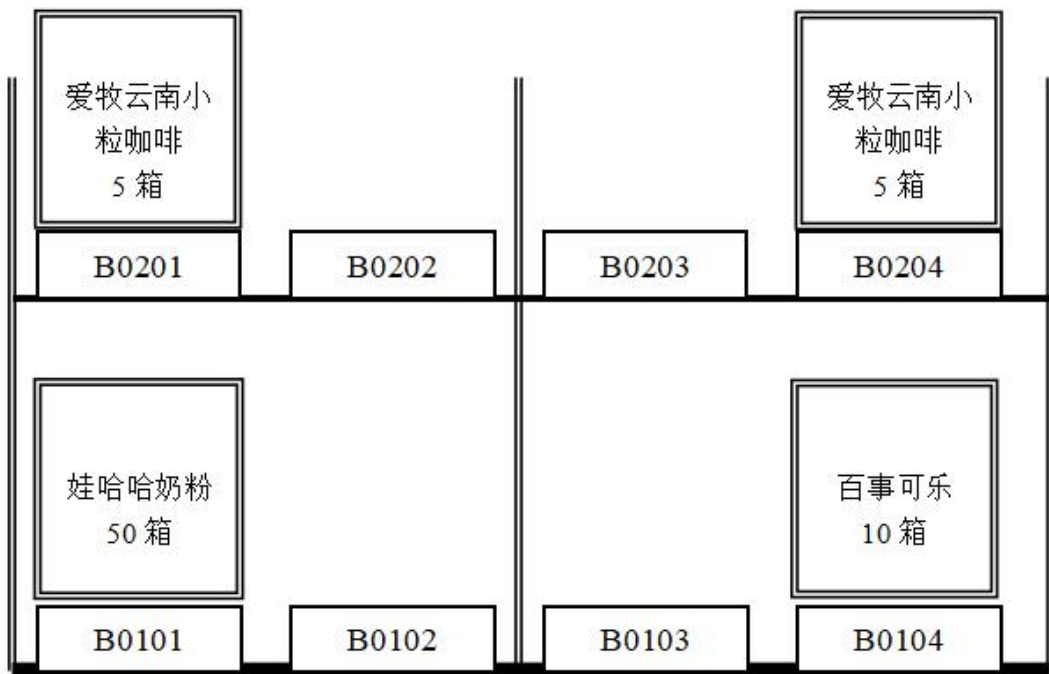
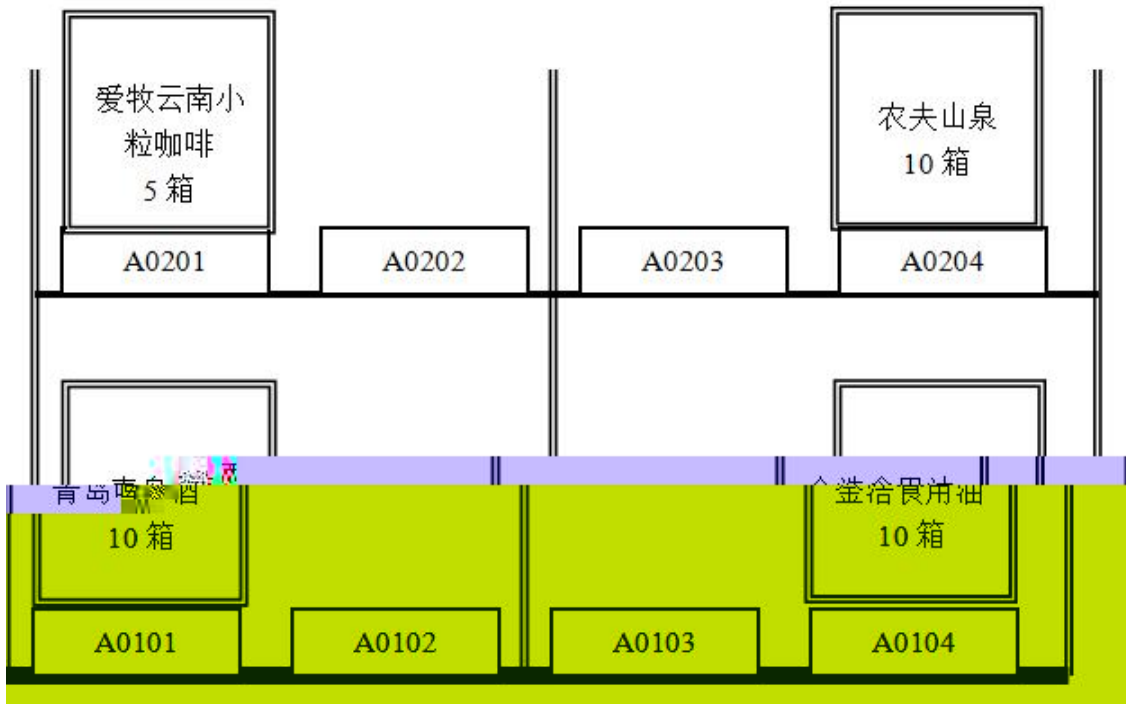

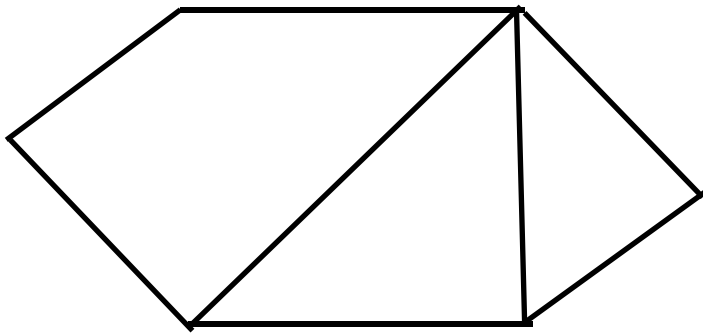

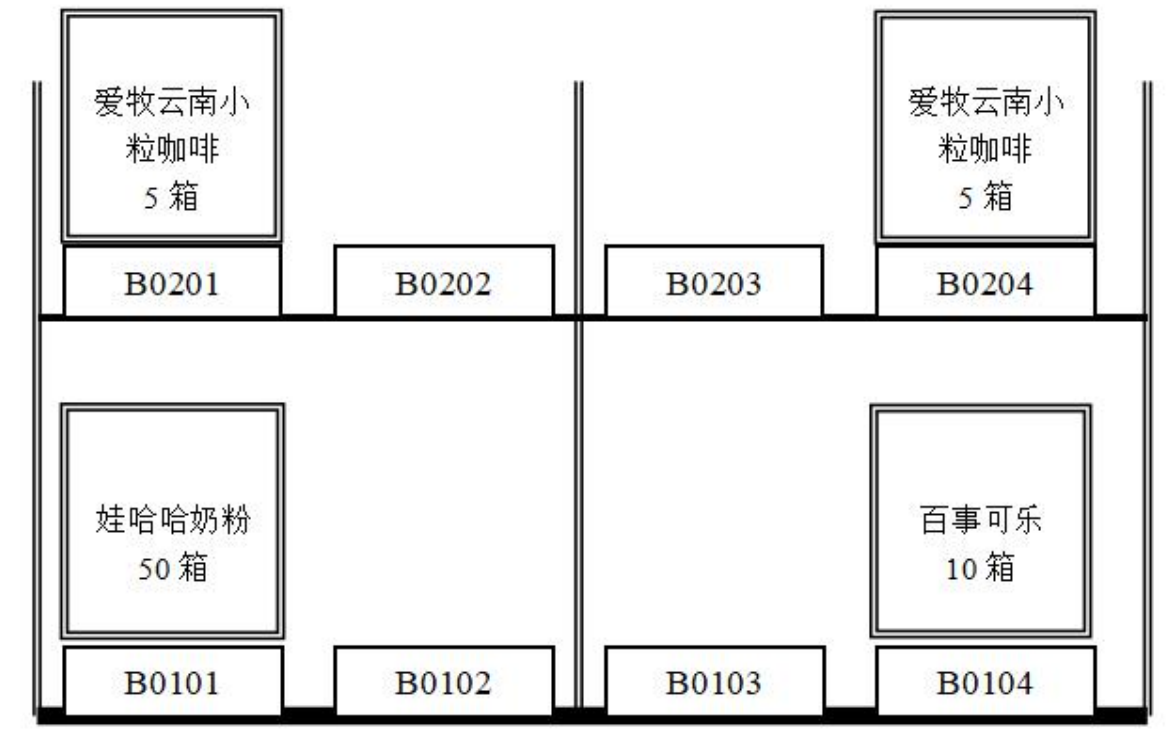
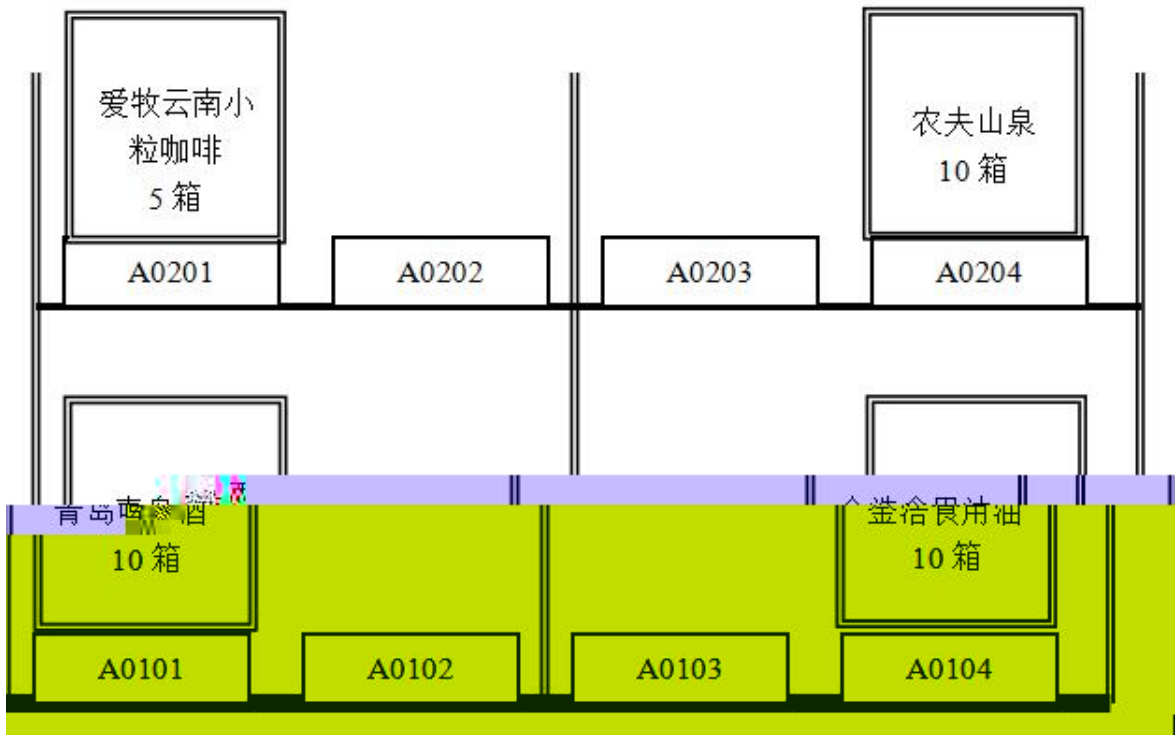



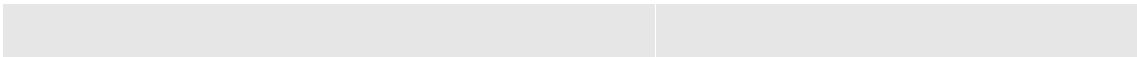

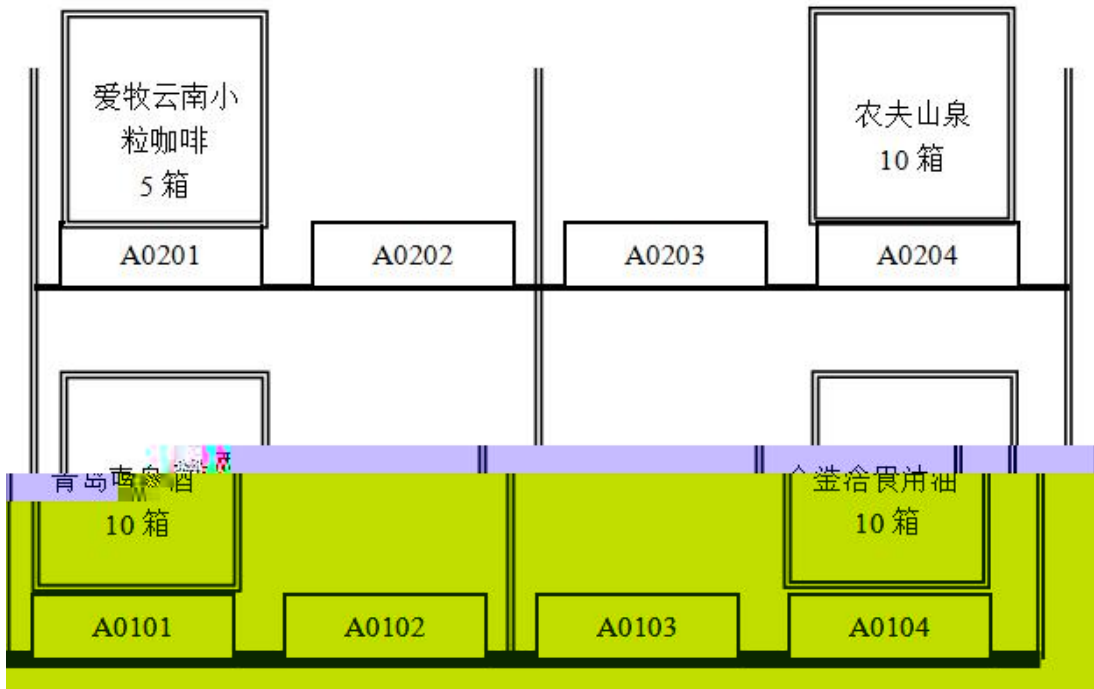

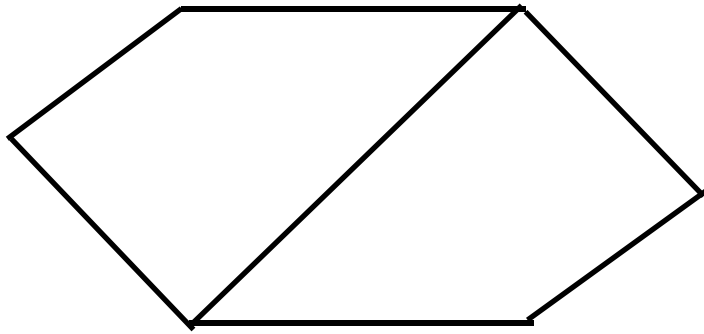

1

--	--	--	--	--	--

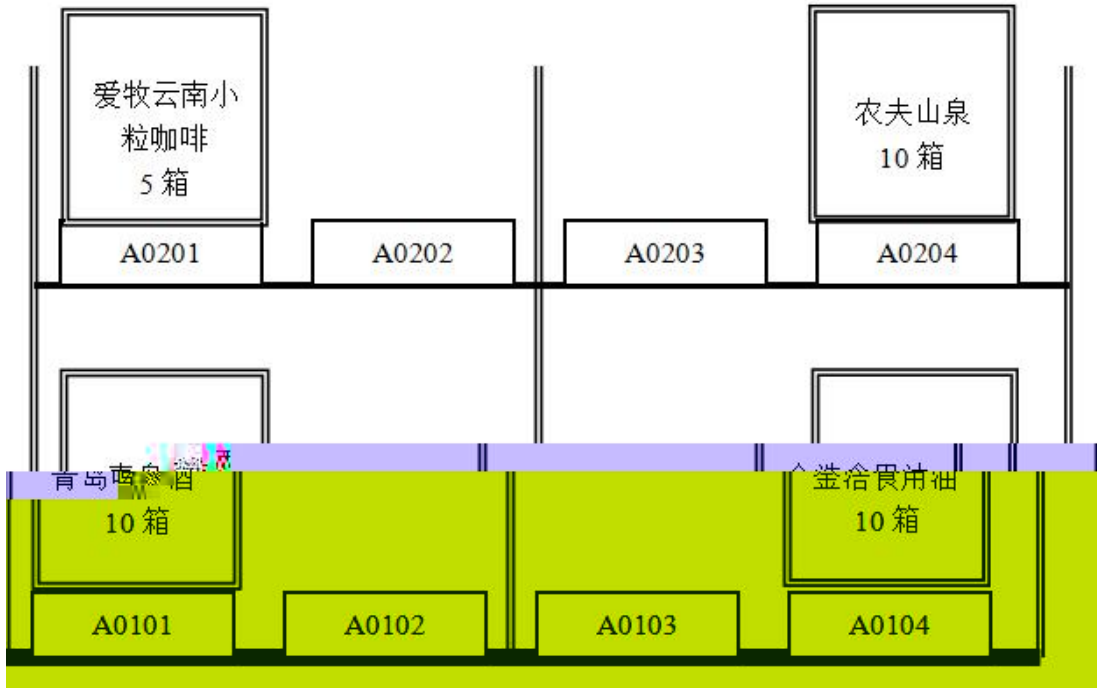

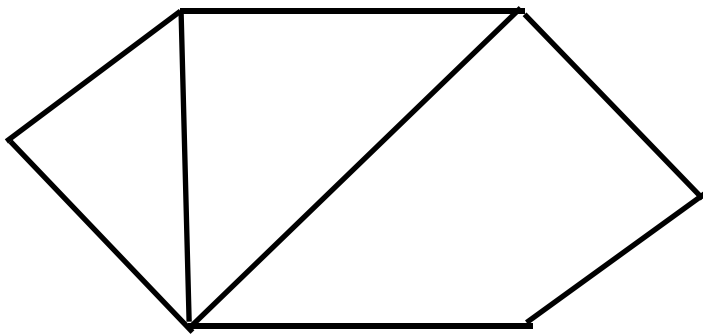

○

○

○

○

○

○

○

○

--	--

○

○

三、国际物流作业组织与管理模块

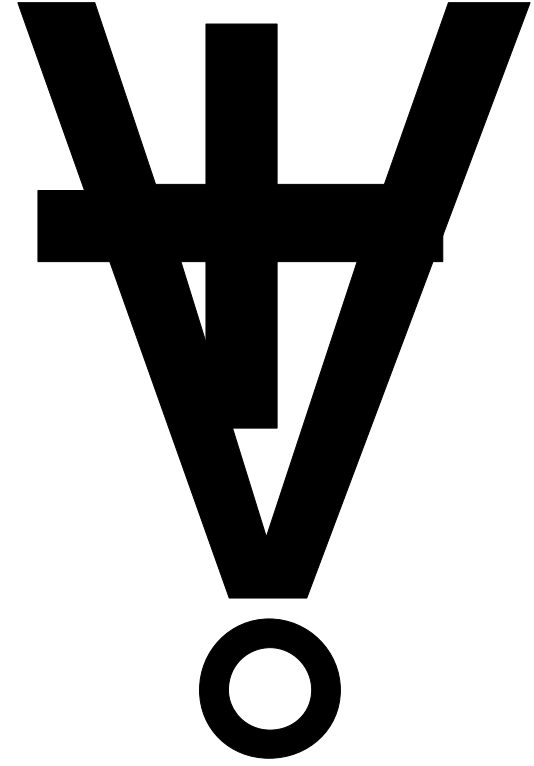

○



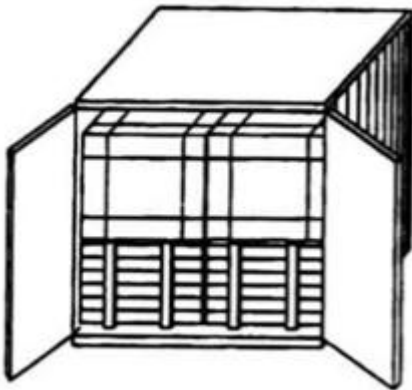
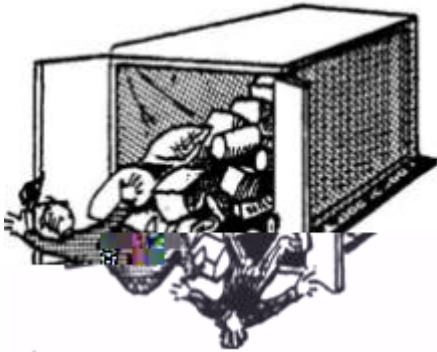
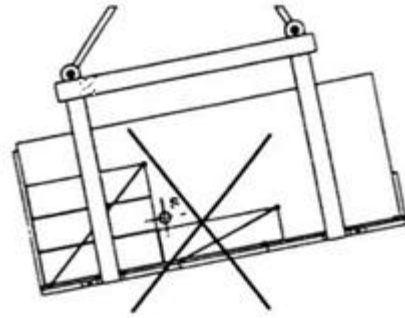

○

船公司 Carrier	船名/航次	服务代码	航线	装船港/卸船港	启-达日期	天	挂港
			Lane	Load/Unload Port	ETD-ETA		Day
运价 船名	MSC 地中海航运	MASTER HQ409E		中国-港澳台	HONG KONG 香港 KAOHSIUNG 高雄	02/25(二) 03/15(六)	18
运价 船名	NYK 日本邮船	ITALIAN EXPRES S/024		中国-东南亚	HONG KONG 香港 BANGKOK 曼谷	02/25(二) 03/02(日)	5
运价 船名	CMA-CGM 达飞轮船	CMA CGM GEMINI TXA49E		中国-非洲	XIAMEN 厦门 DURBAN 德班	02/25(二) 03/27(四)	30
运价 船名	KLINE 川崎汽船	HYUNDAI PLATINU M/004W		中国-中南美	SHANGHAI 上海 PARANAGUA 巴拉那瓜	02/25(二) 04/09(三)	43
运价 船名	DMS 达茂轮船	COSCO KAOHSIUN G/GFS46E		中国-澳新	HONG KONG 香港 NOUMEA 努美阿	02/25(二) 04/02(三)	36
运价 船名	RCL 劳海船运	KOTA PERMASAN VPM114		中国-中东/ 波斯湾/印巴	QINGDAO 青岛 MADRAS 马德拉斯	02/28(五) 03/18(二)	18
运价 船名	ZIM 以星轮船	KUO HUNG 311	CHINA_VIETN AM(CVX)	中国-港澳台	NINGBO 宁波 HONG KONG 香港	02/25(二) 03/15(六)	18
运价 船名	SAFMARINE 比利时商船	HEIKE P 1404		中国-非洲	KAOHSIUNG 高雄 MINDELO	02/25(二) 04/05(六)	39
运价 船名	CSAV 南美船船	CAP SAN NICOLA S/01409		中国-中南美	SHANGHAI 上海 RIO GRANDE 里奥格兰德	02/25(二) 04/07(一)	41
运价	OOCL 东方海外	DRESDEN EXPRES S/16E08	Pacific Atl antic (PAX)	中国-美东	SHANGHAI 上海 HALIFAX 哈利法克斯	02/25(二) 04/14(一)	48

○
○

BEIJING	CN		BJ\$
Y. RENMINBI	CNY		KGS
		100	100.00
		200	200.00
		300	300.00
		400	400.00
		500	500.00
		600	600.00
		700	700.00
		800	800.00
		900	900.00
		1000	1000.00

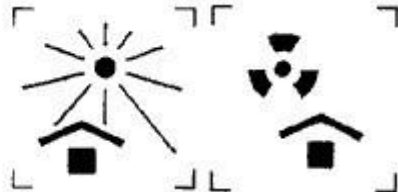

○

○

○

**集装箱设备交接单
EQUIPMENT INTERCHANGE RECEIPT**

OUT 出场

用箱人/运箱人(CNTR. USER/HAULIER)		提箱地点(PLACE OF DELIVERY)	
发往地点(DELIVERED TO)		返回/收箱地点(PLACE OF RETURN)	
船名/航次(VESSEL/VOYAGE No.)	集装箱号(CNTR. No.)	尺寸/类型(SIZE/TYPER)	承运人(CNTR. OPTR)
船名/航次(VESSEL/VOYAGE No.)	集装箱号(CNTR. No.)	箱封号(SEAL No.)	免费期限(FREE TIME PERIOD)
货重(CARGO W.)	出场目的/状态(PPS OF GATE-OUT/STATUS)	进场目的/状态(PPS OF GATE-IN/STATUS)	出场日期(TIME-OUT) 月 日 时
出场检查记录(INSPECTION AT THE TIME OF INTERCHANGE)			
普通集装箱(GP. CNTR.)	冷藏集装箱(R. CNTR.)	特种集装箱(SPL. CNTR.)	发电机(GEN. SET)
<input type="checkbox"/> 正常(SOUND)	<input type="checkbox"/> 正常(SOUND)	<input type="checkbox"/> 正常(SOUND)	<input type="checkbox"/> 正常(SOUND)
<input type="checkbox"/> 异常(DEFFECTIVE)	<input type="checkbox"/> 异常(DEFFECTIVE) 记录程度(RECORDED)	<input type="checkbox"/> 异常(DEFFECTIVE)	<input type="checkbox"/> 异常(DEFFECTIVE)
损坏记录及代号(DAMAGE CODE)			



--	--	--	--	--	--

--	--	--

--	--	--	--	--	--

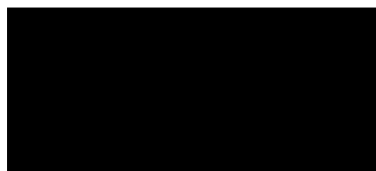

--	--	--	--	--	--

--	--	--	--	--	--	--	--

○



*6



#AIC 2024

○

--	--	--

--	--	--	--	--	--

○

○

○

○

四、 快递物流作业组织与管理模块

--	--	--	--	--	--

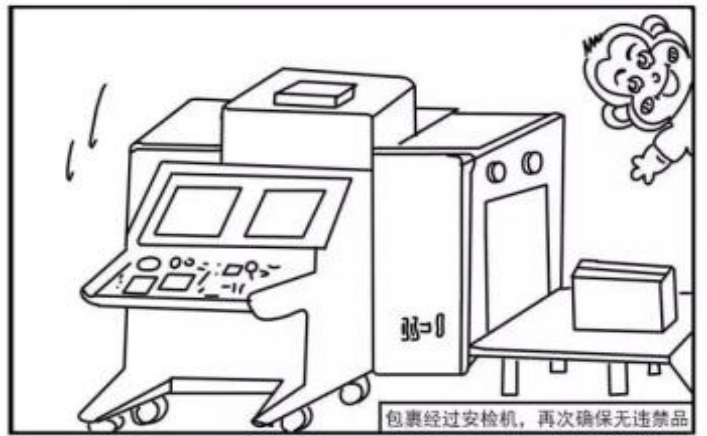

--	--	--	--	--	--

--	--	--	--	--	--

[想知道:中国成都理工大学校园快递具体在哪? 百度知道](#)

3个回答 - 提问时间: 2014年02月10日

最佳答案: 韵达在银杏后面。宝盒、圆通、顺丰在电影院后面。中通、申通在图书馆下面。常用的是这几个。

[zhidao.baidu.com/link?... 2014-02-15](#) - 百度快照 - 80%好评

--	--	--	--

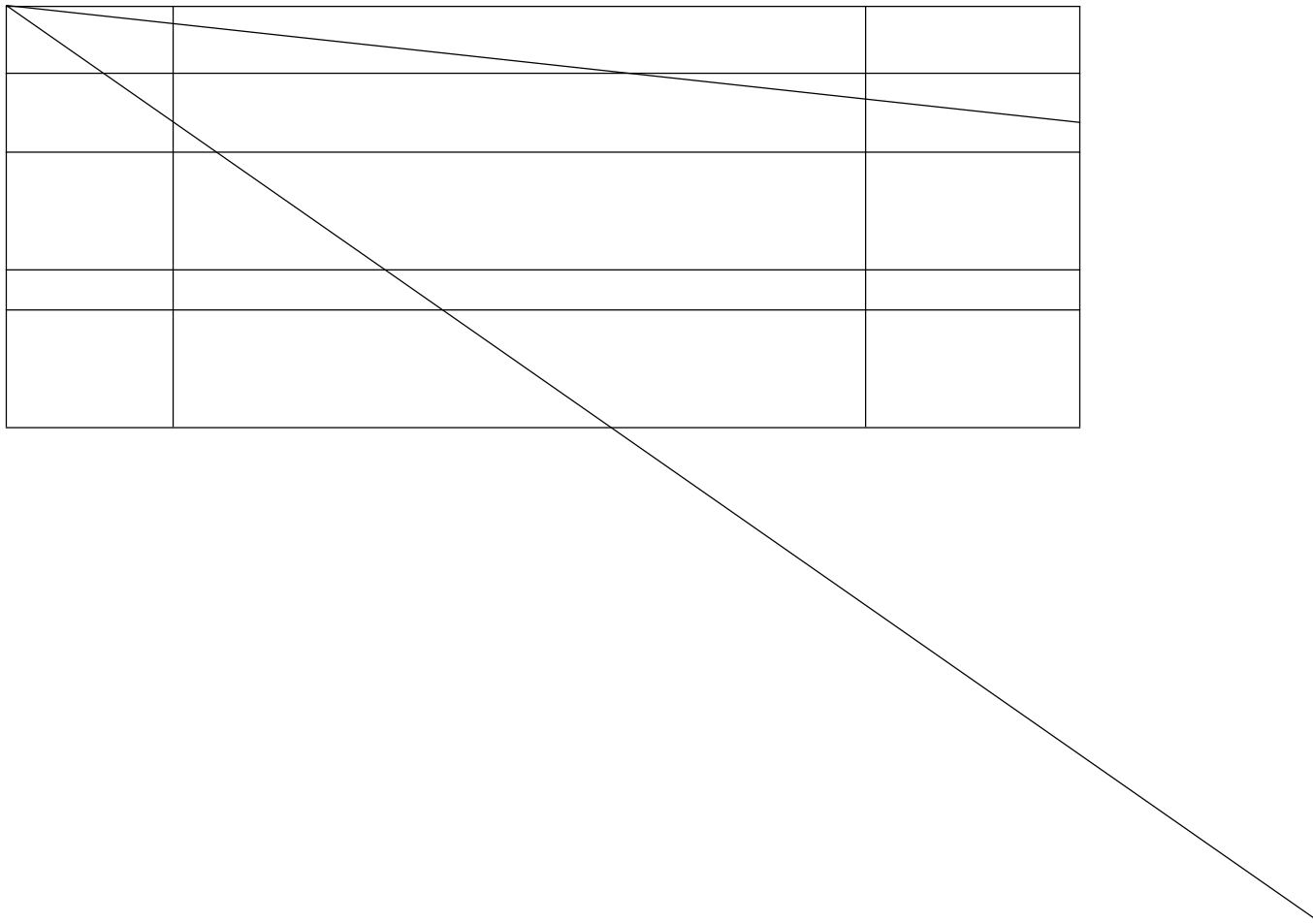

--	--	--	--

--	--

